

TECHNOLOGY



Data Pulse

Advanced control and power for precise dimming and efficient signal handling.



Data Whisper

Automates address assignment for DMX lighting in the Data Pulse network, ensuring easy setup and system reliability.



Color Shout

Enhances LED brightness and color saturation, efficiently managing power for fewer, high-quality luminaires.



X Line

Efficiently distributes power and data in lighting systems, simplifying installation and enhancing energy efficiency.



Split & Seal

Uses protective polymers to shield Filix products from water and moisture, boosting durability and resilience.



Heat Sense

Automatically reduces LED power at high temperatures, ensuring longevity and safety in Filix products.

Hemera Hecto



ASHRAE/IEC 90.1 Compliant

Defines energy efficiency standards for building design, focusing on insulation, HVAC, and sustainable energy use.

Qualicoat Seaside Class Powder Coat

Enhanced powder coating for aluminum, specifically formulated for superior durability and optimal performance in marine environments, lasting for over 10 years.



Hemera Hecto

Specification Sheet



UL STD 1598 PENDING
IP66/IP67

LUMINAIRE FEATURES

Design and Application

- Facade lighting
- Architectural lighting

Mechanical details

- IK07/IK10* clear tempered glass 4mm
- UL STD 1598, IP66/IP67, Wet location
- 3G vibration rating resistance (ANSI C136.32)
- Extruded aluminum body
- Double surface protected with anodised base layer and powder coat top layer in Qualicoat Seaside standard

Electrical details

- Lifetime TM-21 @105C L80(24K)=145000h
- Operating temperature -40°F to +122°F
- LED CRI: >85
- On site LED module replacement
- On site engine replacement

Sustainability

- 91% Recyclable
- 95% Repairable
- Dark-sky compliant

Controls

- DMX (Data Pulse)
- DALI
- 0-10V

Integrated Systems:

- Data Whisper
- Colour Shout
- X Line
- Split & Seal
- Heat Sense

Links and Downloads

- [Fixture installation manual](#)
- [CAD files](#)
- [IES-LTD data](#)



Hemera Hecto

ORDERING INFORMATION

MODEL		VOLTAGE	
FHC		110	• 110 - 110-277VAC, 60Hz
LENGTH		230	• 230 - 220-240VAC, 50Hz
03	• 320mm (12,6")	CONTROL	
06	• 620mm (24,4")	0	• 0 - ON-OFF operation
09	• 920mm (36,2")	X	• X - DMX operation
12	• 1220mm (48")	D	• D - DALI operation
POWER		V	• V - 0-10V operation
L	• L - 5W/ft - 548lm/ft - ASHRAE compliant	FINISH	
	• L - 5W/ft - RGBW (W 3000K)	W	• W - RAL9003 Structure (Signal White)
	• L - 5W/ft - RGBA (A Amber)	S	• S - RAL7044 Structure (Silky Grey)
	• L - 5W/ft - TW (2200K-4000K)	A	• A - RAL7016 Structure (Antracite Grey)
H	• H - 12W/ft - 1281lm/ft	B	• B - RAL9005 Structure (Jet Black)
	• H - 12W/ft - RGBW (W 3000K)	INTERNAL GLARE CONTROL	
	• H - 12W/ft - RGBA (A Amber)	0	• 0 - No internal glare control
	• H - 12W/ft - TW (2200K-4000K)	1	• 1 - Microlouvre
COLOR TEMP.		2	• 2 - Hex louvre
AM	• AM - Amber	3	• 3 - Discrete sight
27	• 27 - 2700K	EXTERNAL GLARE CONTROL	
30	• 30 - 3000K	0	• 0 - No external glare control
40	• 40 - 4000K	1	• 1 - Single-sided shield
T6	• T6 - 2200K-4000K	2	• 2 - Triple-sided shield
M4	• M4 (W 3000K)	3	• 3 - Asymmetric linear louvre
M1	• M1 (A Amber)		
OPTICS			
NS	• NS - Narrow Spot 8°x8°		
MS	• MS - Medium Spot 15°x15°		
NF	• NF - Narrow Flood 30°x30°		
MF	• MF - Medium Flood 40°x40°		
W	• W - Wide 60°x60°		
SY	• SY - Spot Asymmetric 10°x20°		
NY	• NY - Narrow Asymmetric 10°x40°		
MY	• MY - Medium Asymmetric 10°x60°		



Hemera Hecto

MANDATORY ACCESSORIES

Feed Cables - art. FFCUTL4P

LENGTHS

- | | |
|----|-----------------------|
| 1 | • 1 - 3' feed cable |
| 3 | • 3 - 10' feed cable |
| 6 | • 6 - 20' feed cable |
| 9 | • 9 - 30' feed cable |
| 20 | • 20 - 65' feed cable |

End caps

END CAPS

- | | |
|--------|--------------------|
| 104964 | • 104964 - End cap |
|--------|--------------------|



Hemera Hecto

OPTIONAL ACCESSORIES

Jumper Cables - art. FJCUTL4PC

LENGTHS

- | | |
|----|-------------------------|
| 1 | • 1 - 3' jumper cable |
| 3 | • 3 - 10' jumper cable |
| 6 | • 6 - 20' jumper cable |
| 9 | • 9 - 30' jumper cable |
| 20 | • 20 - 65' jumper cable |

Splitters - art. SUTL4P2WPDS

SPLITTERS

- | | |
|----|------------------------------|
| P | • P - Power splitter |
| D | • D - Data splitter |
| PD | • PD - Power & Data splitter |

Various Accessories

VARIOUS

- | | |
|--------|-----------------------------|
| 203953 | • 203953 - Safety wire rope |
|--------|-----------------------------|



Hemera Hecto

INSTALLATION DETAILS

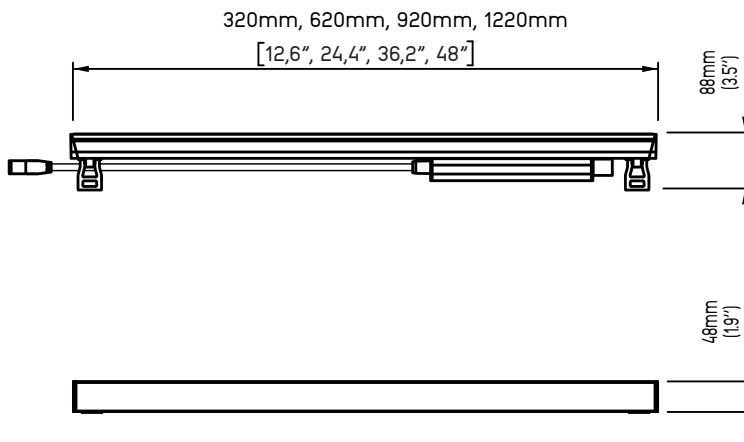

The standard luminaires are equipped with cables, facilitating seamless line connections with a 5mm [0.2"] gap to account for material expansion. In cases where the luminaires are not installed end-to-end for electrical connection, specialized jumpers are employed. More detailed information about these jumpers can be found in the cable accessories section.

Continuous end-to-end arrangement

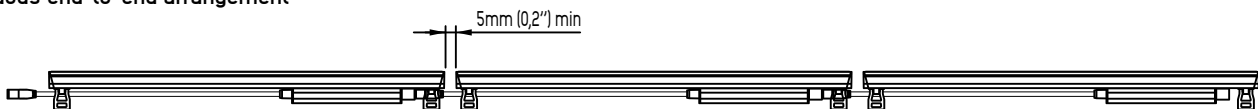

The length of the continuous end-to-end arrangement typically varies depending on the type of product in use and is generally influenced by the product's power requirements. You can find the specific maximum number of products that can be installed on a single fuse in the table located in the network topology section.

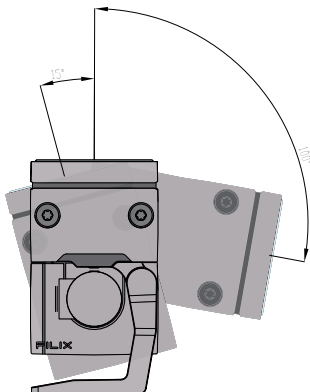

Adjustable tilt

Compliant with ANSI C136.31 standard for vibration conditions on bridges and overpasses. Designed to allow product tilt of 125°. The installation should be performed as per local codes and different applications but the bracket allows adjustment in terms of position on the product and with slots that are designed for 6mm bolt.



Hemera Hecto

GLARE CONTROL

External glare control accesories:

Single-sided shield

Used for efficient light channeling in end-to-end applications.

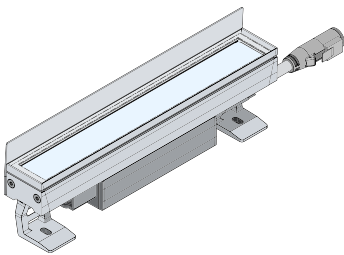

Triple-sided shield

Used for efficient light channeling in standalone applications.

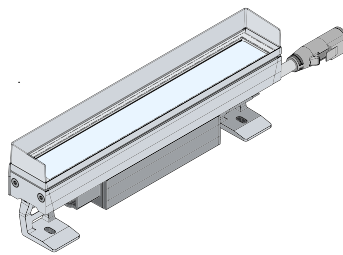

Asymetric linear louvre

Utilized for precise light channeling in situations requiring stringent glare control. Each optic is individually shielded, and a PC cover has been incorporated to hinder dirt buildup between slats.

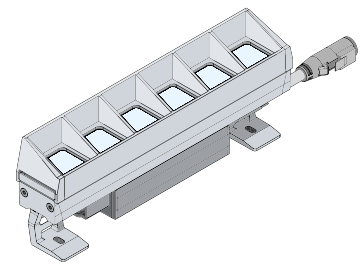

Internal glare control:

Microlouvre

Provides low glare control with 30% less lumen output than product without louvres. best for use where pedestrians are at least 6m from the light source

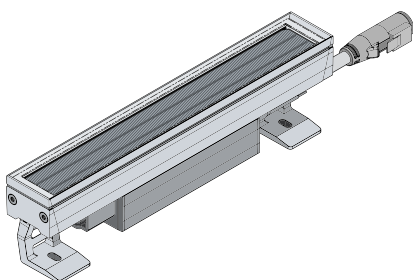

Hex louvre

Provides low glare control with 45% less lumen output than product without louvres. best for use in moderate traffic where pedestrians are at least 3m from the light source

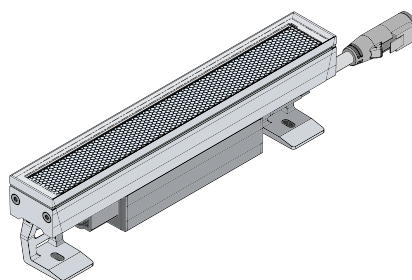

Discrete sight

Provides low glare control with 60% less lumen output than product without louvres. best for use in high traffic areas where pedestrians are at least 0,5m [1.64ft] away from the source

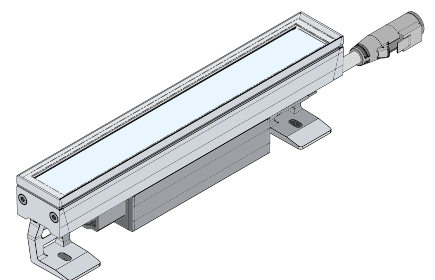



Hemera Hecto

MANDATORY ACCESSORIES

Feed cable

Length options 3ft, 10ft, 20ft, 30ft, 65ft.
The rugged rubber cables are versatile, with open wires for mains connection and a snap-in connector for fixture connection. They're rated IP68/IP69K and resistant to UV exposure, ideal for marine use. Note that feed cables are mandatory to order.

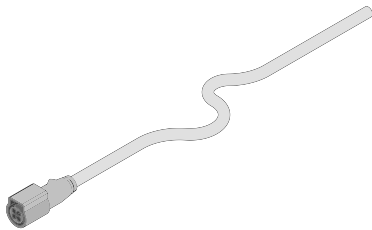

End cap

Endcap for receptacle, providing IP67 protection when securely locked. Required for all runs terminations, excluding those under DMX (Data Pulse) control.

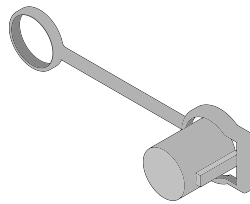



Hemera Hecto

OPTIONAL ACCESSORIES

Jumper cable

Length options 3ft, 10ft, 20ft, 30ft, 65ft. Jumper cables, a necessity for non-end-to-end configurations, feature connectors on both ends for easy connection. Constructed with robust rubber material, they endure mechanical stress and harsh environments. Rated IP68/IP69K and resistant to UV exposure, they are ideal for marine applications.

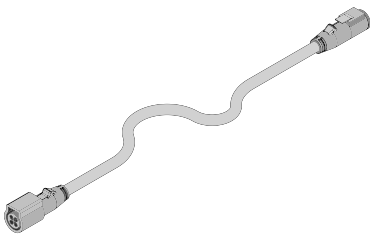

Safety wire rope

12" long safety bond for added security during high-altitude installations

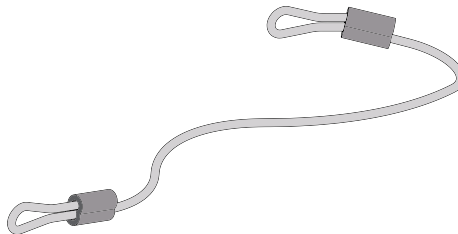

Data Splitter

A Data Splitter serves in DMX (Data Pulse) applications when there's untapped capacity on the fuse for additional fixtures. This device efficiently utilizes available resources by allowing one fuse to serve two separate DMX universes. By simplifying cabling and streamlining data flow, it optimizes lighting setup, making it more efficient and cost-effective.

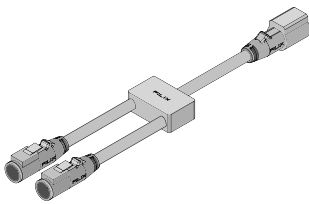

Power & Data Splitter

A Power & Data Splitter plays a crucial role in DALI, and 1-10V applications, especially when there's a requirement to establish "tree" or "star" connection topologies. This versatile splitter excels at efficiently distributing both power and data, enabling seamless branching out of your lighting system.

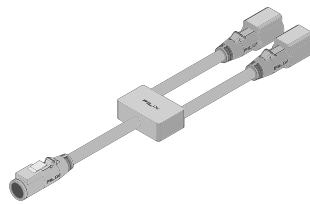

Power Splitter

A Power Splitter is crucial for handling ON/OFF applications, particularly when there's a requirement for branching connections in "tree" or "star" topologies. This splitter facilitates the effective distribution of power, guaranteeing a smooth expansion of your lighting network.

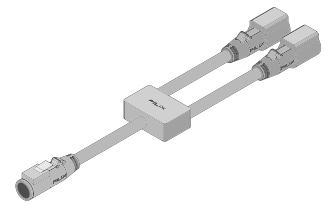



Hemera Hecto

OPTICS

Narrow Spot
Angle: 8°x8°
Delivered lumen: 1281lm/ft

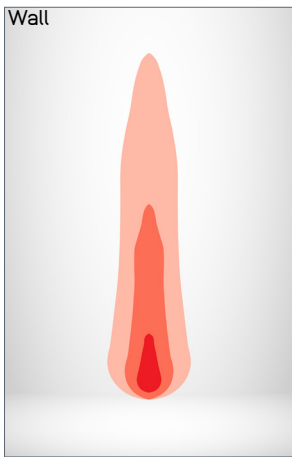
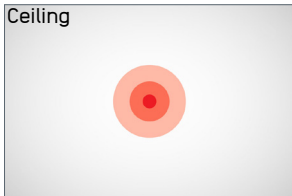

Medium Spot
Angle: 15°x15°
Delivered lumen: 1250lm/ft

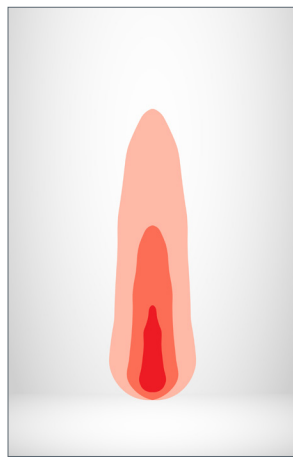
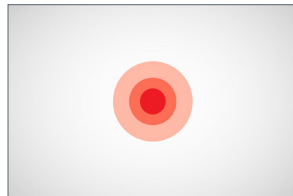

Narrow Flood
Angle: 30°x30°
Delivered lumen: 1171lm/ft

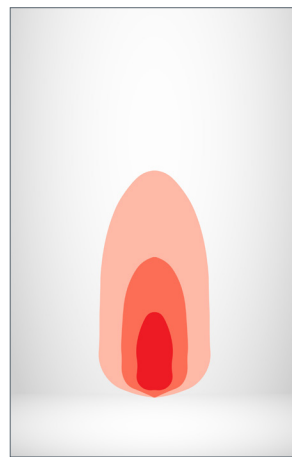
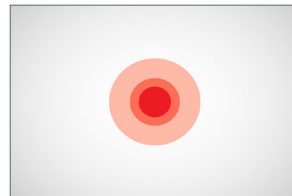

Medium Flood
Angle: 40°x40°
Delivered lumen: 1140lm/ft

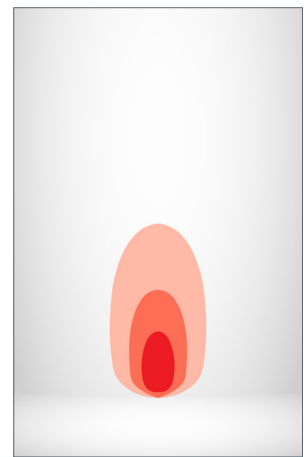
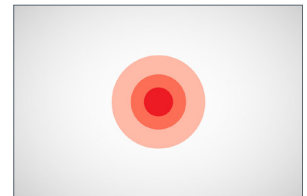

Wide
Angle: 60°x60°
Delivered lumen: 1062lm/ft

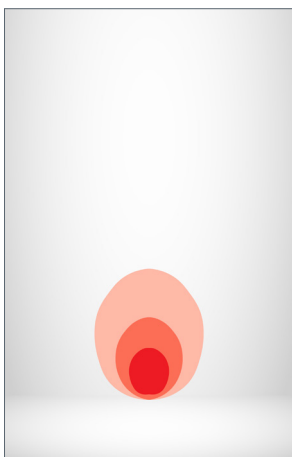
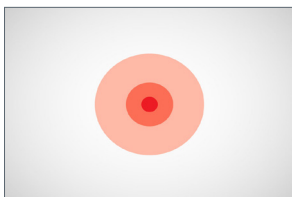

Spot Asymmetric
Angle: 10°x20°
Delivered lumen: 1234lm/ft

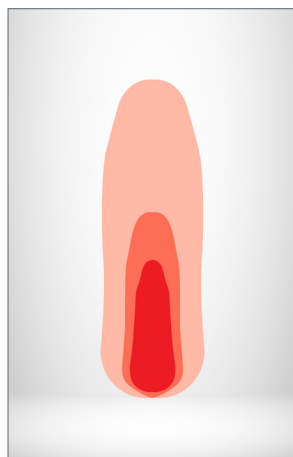
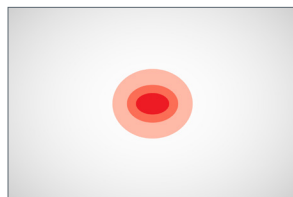

Narrow Asymmetric
Angle: 10°x40°
Delivered lumen: 1203lm/ft

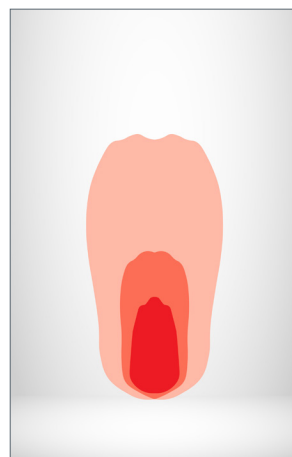
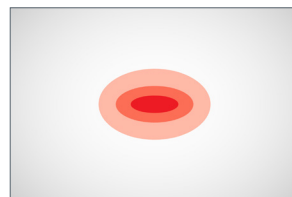

Medium Asymmetric
Angle: 10°x60°
Delivered lumen: 1171lm/ft

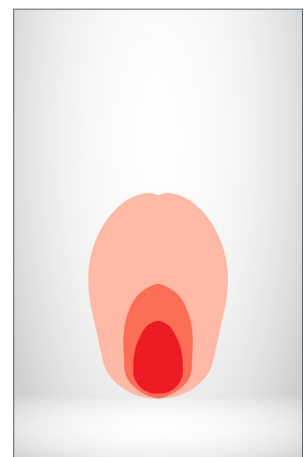
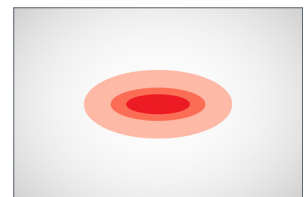

Notes

- Depending on the beam angle and power of the fixture, it has the capability to project light up to 100m (330ft)
- Light output values based on 39W/m [12Wft] and 3000K product



Control

ON/OFF SYSTEM TOPOLOGY

Integrated systems:

- X Line
- Heat Sense
- Split & Seal

System components

- Wiring, protective devices and junction boxes leading up to feed cable at the start of the line are the responsibility of others
- Feed cables and necessary accessories that are marked as mandatory must be ordered separately
- For optional branching of the system Power Splitter must be used
- Advised protective components:
 - Surge protector device
 - Inrush current limiter

System topology

- In the system design, any of the following system topologies can be utilized: line wiring, star wiring, or tree wiring.

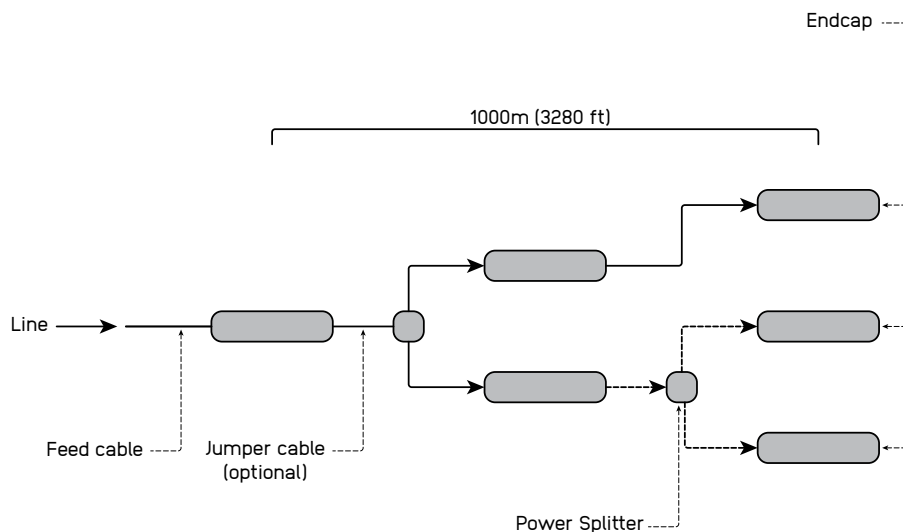

Addressing & dimming notes

- ON/OFF system does not allow device addressing
- Dimming of the product not available in this system

Segment length and limitations

- The minimum segment length is equal to one product
- The maximum distance between the first and last fitting is limited to maximum voltage drop and fuse rating.
- Used only in single colour applications

Fault tolerance

- If one product fails the rest of the system continues to work
- Class I wiring implemented in the fixture and voltage fluctuation filter implemented



Control

0-10V SYSTEM TOPOLOGY

Integrated systems:

- X Line
- Heat Sense
- Split & Seal

System components

- The 0-10V system, wiring, protective devices and junction boxes leading up to feed cable at the start of the line are the responsibility of others
- Feed cables and necessary accessories that are marked as mandatory must be ordered separately
- For optional branching of the system Power & Data Splitter must be used
- Advised protective components:
 - Surge protector device
 - Inrush current limiter

System topology

- In the system design, any of the following system topologies can be utilized: line wiring, star wiring, or tree wiring.

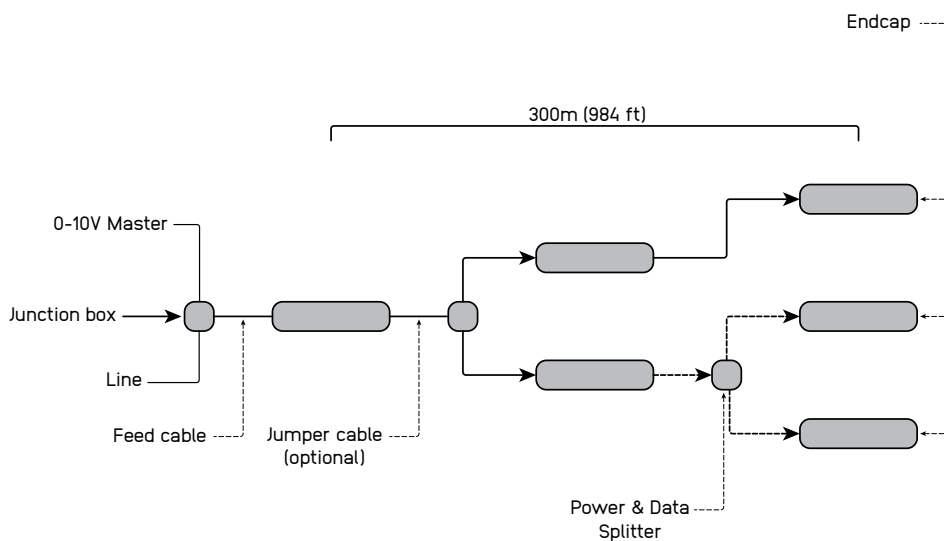

Addressing & dimming notes

- 0-10V protocol does not allow addressing devices individually
- Logarithmic and linear dimming options available. The product is initially equipped with logarithmic dimming settings and it is suggested for the controllers to be linear in order to get the dimming that is most preferred in most cases due to the dimming curve perceived by human eye
- 0%-100% dimming range
- The product is initially set up as a source instead of as a sink type
- The product could also be set up as a sink type but this should be noted to sales representative

Segment length and limitations

- The minimum segment length is equal to one product
- The maximum distance between two fittings is 30 meters [98ft], and the maximum distance between the first and last fitting is 300m (984ft).
- Used in single colour applications

Fault tolerance

- If the product is source type and in the case the control line doesn't have power the light fitting will turn at 100%. in the opposite case where the light is sink type, light will not work.
- If one product fails the rest of the system continues to work
- Class I wiring implemented in the fixture and voltage fluctuation filter implemented



Control

DALI SYSTEM TOPOLOGY

Integrated systems:

- X Line
- Heat Sense
- Split & Seal

System components

- The DALI system, wiring, protective devices and junction boxes leading up to feed cable at the start of the line are the responsibility of others
- Feed cables and necessary accessories that are marked as mandatory must be ordered separately
- For optional branching of the system Power & Data Splitter must be used
- Advised protective components:
 - Surge protector device
 - Inrush current limiter

System topology

- In the system design, any of the following system topologies can be utilized: line wiring, star wiring, or tree wiring.

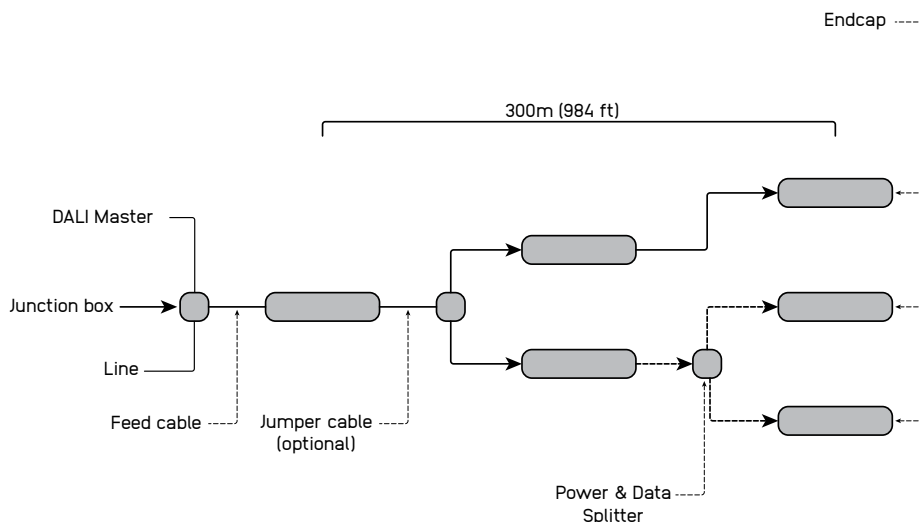

Addressing & dimming notes

- DALI protocol allows addressing devices individually
- Addressing methods include a short address for individual devices, group addresses for up to 16 groups, and a broadcast address that targets everything on the line.
- Logarithmic and linear dimming options available. the product is initially equipped with logarithmic dimming settings, while you can easily switch to logarithmic dimming using a configuration device.
- 0%-100% dimming range

Segment length and limitations

- The minimum segment length is equal to one product
- A DALI master has the capacity to manage a line containing a maximum of 64 devices. Each device can be allocated to 16 unique groups and 16 individual scenes.
- The maximum distance between two fittings is 30 meters [98ft], and the maximum distance between the first and last fitting is 300m (984ft).
- Used in single colour and tunable white applications

Fault tolerance

- Due to its relatively slow operating speed and high bus voltage, the DALI system exhibits significant reliability in the presence of electrical interference, making shielding unnecessary
- If one product fails the rest of the system continues to work



Control

DMX SYSTEM TOPOLOGY

Integrated systems:

- Data Pulse: One unit for both power management and data control when utilizing the DMX protocol.
- Data Whisper
- X Line
- Colour Shout
- Heat Sense
- Split & Seal

System components

- The DMX system, wiring, protective devices and junction boxes leading up to Data Pulse at the start of the line are the responsibility of others
- Feed cables and necessary accessories are mandatory and must to be ordered separately
- For optional branching of the system power & data distributor must be used
- Advised protective components:
 - Surge protector device
 - Inrush current limiter

System topology

- In the system design, line wiring can only be used

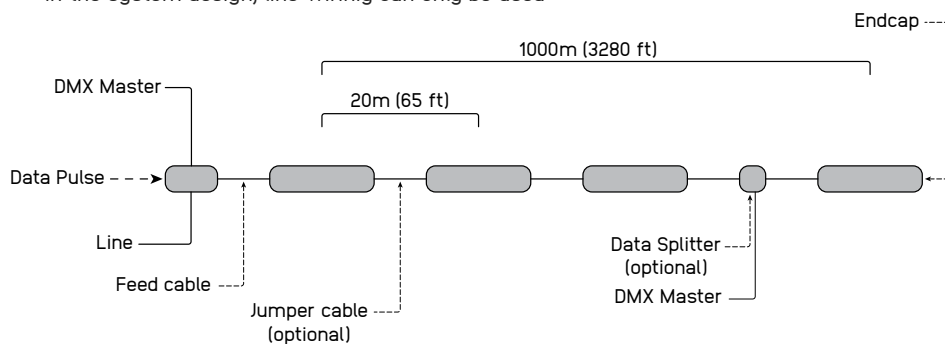

Addressing & dimming notes

- DMX protocol allows addressing devices individually
- Addressing methods allow short address for individual devices
- Logarithmic and linear dimming options available. the product is initially equipped with logarithmic dimming settings, while you can easily switch to logarithmic dimming using a configuration device.
- 0%-100% dimming range

Segment length and limitations

- The minimum segment length is 30cm [1ft]
- A DMX universe has the capacity to manage a line containing a maximum of 512 addresses. each device can be allocated to maximum 4 unique addresses of 30cm [1ft] length
- The maximum distance between two fittings is 30m (98ft), and the maximum distance between the first and last fitting is 1000m (3280ft).
- Used in single colour, tunable white, and RGBW applications
- DMX addresses can be programmed in factory or on site. Consult your sales representative if addressing is to be done in factory

Fault tolerance

- Due to Data Pulse technology, the DMX system exhibits significant reliability in the presence of electrical interference, making shielding unnecessary
- If one product fails the rest of the system continues to work